

---

# **French product repair manual**

Model:VEFFD3018RISL  
VEFFD3316RISL

BCD-513W

The first edition of

# directory

- **1. Product features and characteristics**
- **2. Product appearance structure**
- **3. The main technical parameters of the product**
- **4. Instructions for the operation of the product functions**
- **5. Electrical schematics and wiring diagrams**
- **6. Control principles, parameters and detection methods**
- **7. Refrigeration principle and line cycle diagram**
- **8. Instructions for the removal of the main components**
- **9. Typical fault judgment and troubleshooting**
- **10. Product breakdown chart and parts schedule**

## Chapter 1: Product features and features

1. Refrigerant R600a and foaming agents are hydrocarbons that do not destroy the ozone layer and do not produce a greenhouse effect. The freezer automatically defrosts, eliminating the hassle of manual defrosting.
2. Set frozen, energy saving, noise reduction and other technologies in one, through the optimization of refrigeration systems, energy-saving purposes, and minimize noise.
3. Anti-mold antibacterial removable door seal, clean and hygienic, easy to clean.
4. Metal hinge system, solid and beautiful, can achieve automatic closing, door opening limits.

## Chapter 2: Product appearance structure





**Compressor warehouse picture**



**Refrigeration sensor / refrigeration sensor location description**

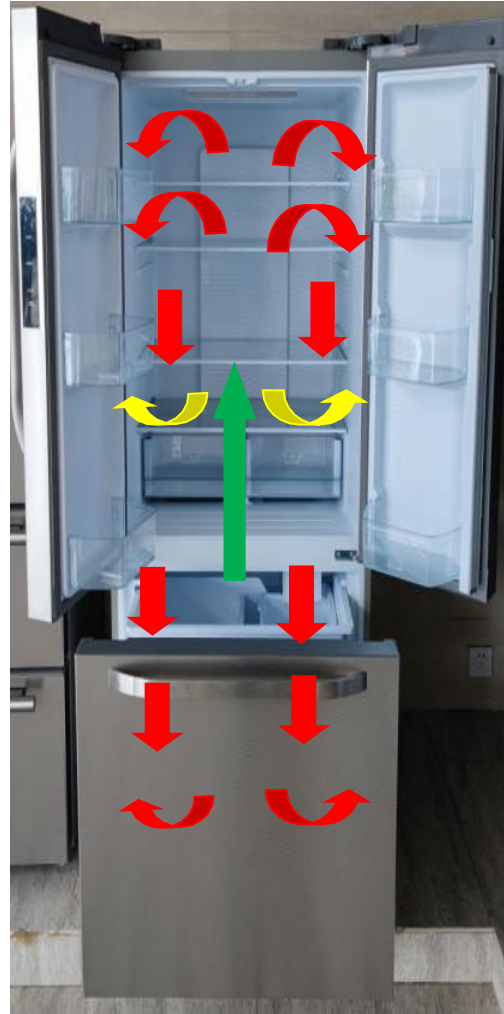

Each room wind road towards



Freezing air duct back cover



Freezing air duct front cover



**Refrigerator fan motor**



**Freezer → air supply outlet of fridge**



**Refrigeration room air duct**



**Refrigeration room back to the air vent**

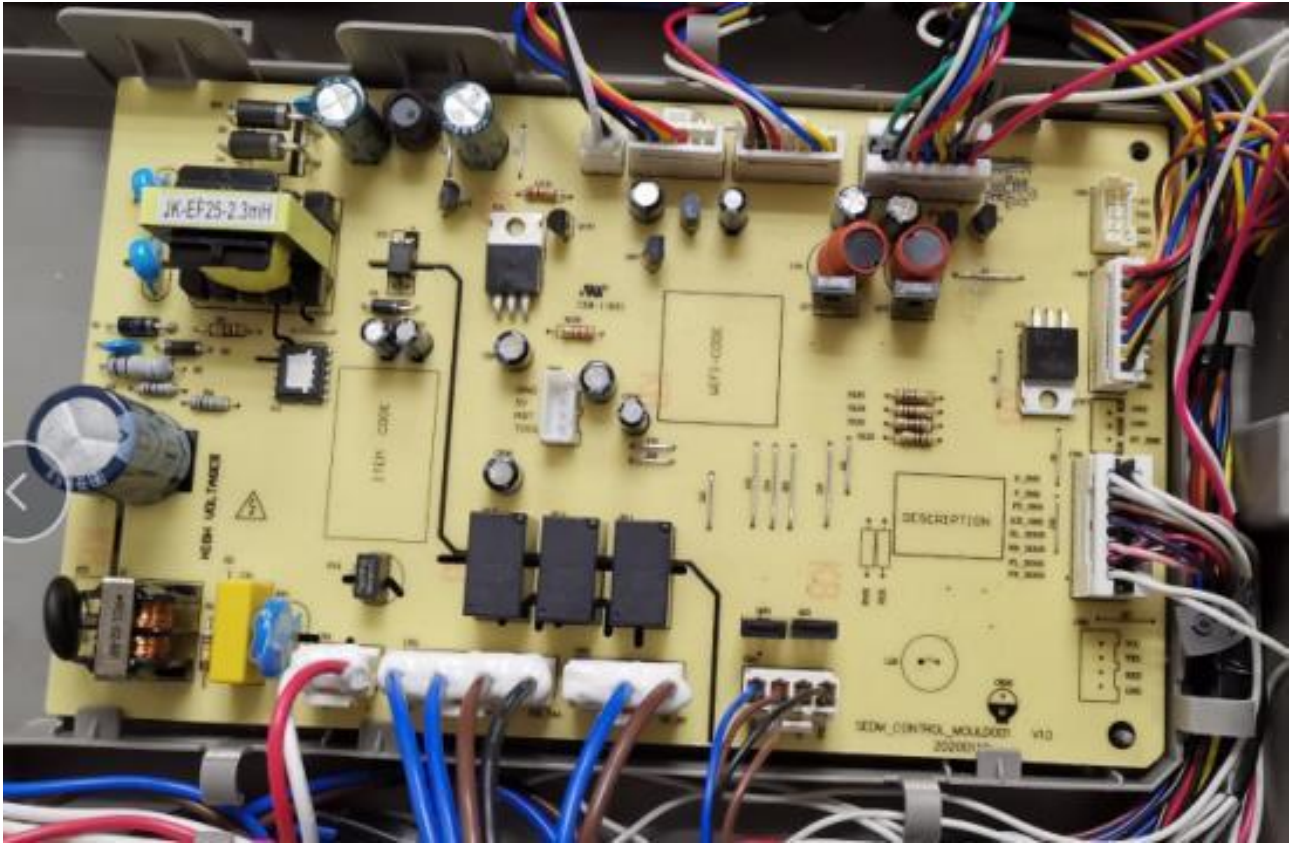

PCB board

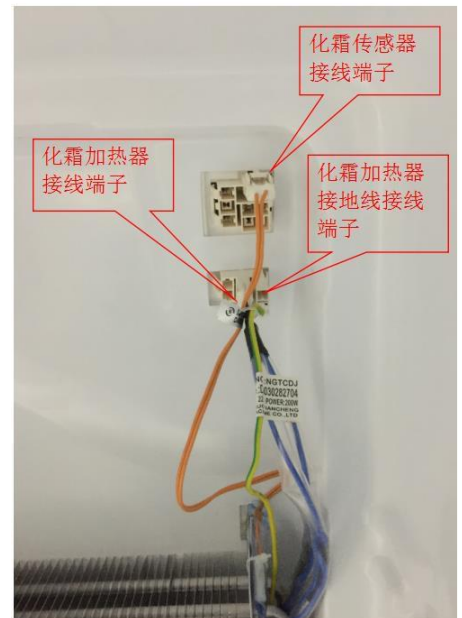
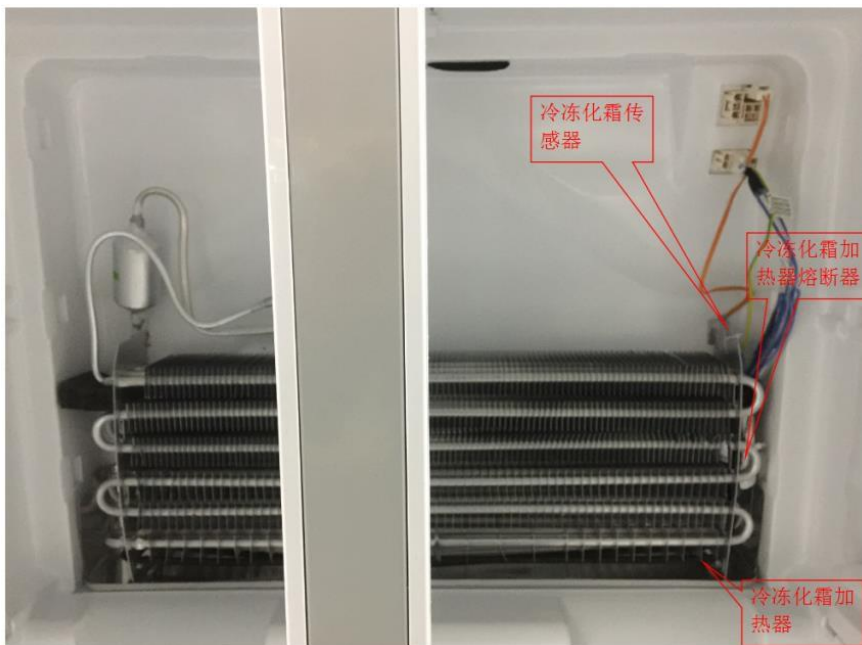

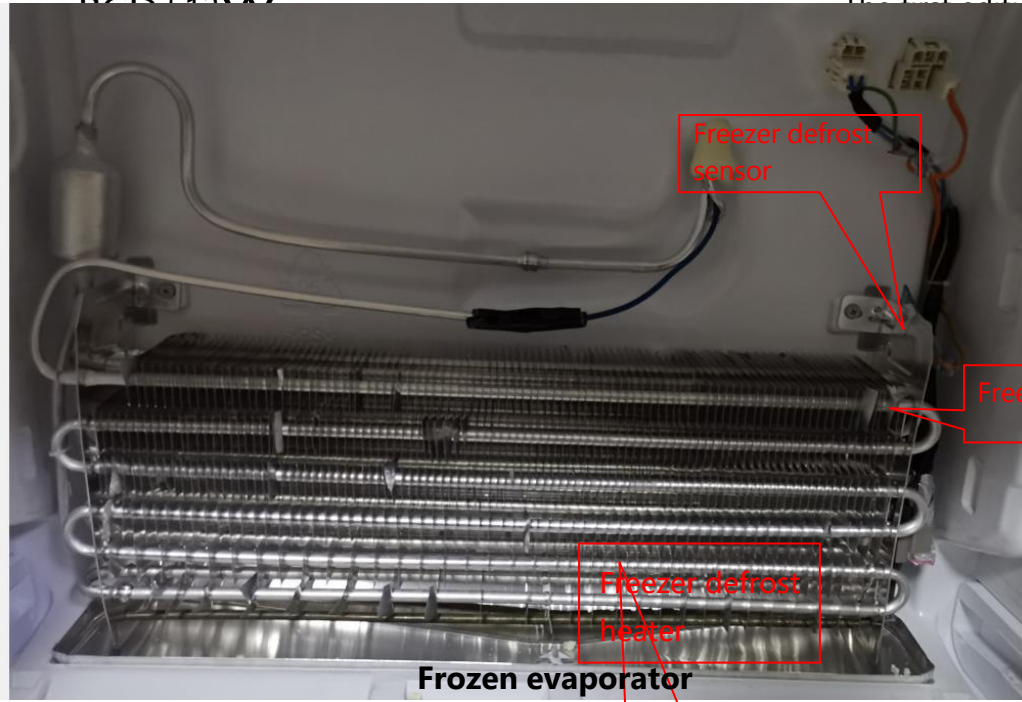

### Chapter 3: Key technical parameters of the product

Total volume (L).	513	Origin	China	Production identification time	/
Freezer (L).	153	Product platform code	W756	The number of cabinets installed	/
Refrigerator (L).	360	ERP product code	/	Dimensions W*D*H (mm).	759mm*742mm* 1780mm
Change greenhouse (L).	/	The color of the product	Customer-specified	Package size W*D*H(mm).	820mm*775mm* 1845mm ***
Door structure					
Door panel material	Stainless steel steel door	handle	Clear handle	Star symbol	✱
End cover of the door	gray	The color of the door panel ( membrane number ).	Dazzling steel	Door shelves	GPPS
Box structure					
Box bile / door bile	HIPS, white	Lights	LED	Fruit box	HIPS
Fruit box cover	HIPS(white)and tempered glass	Freezer drawers	HIPS, white	Evaporator structure	Fin-type evaporator
Transparent color	GPPS, aquamarine blue	Glass shelf	Injection and tempered glass	Net weight (kg).	100.5
Wine rack material	—	The type of fresh retainer	-	Gross weight (kg).	110.5
performance					
Climate type	SN/N/ST/T	Rated voltage (V).	115V	Refrigeration capacity (kg/12h).	/
Whether to compensate automatically	not	Rated frequency (Hz).	60HZ	Change the greenhouse temperature range (	-
Standard power consumption	1.13kW·h/24h	Current (A).	/	Refrigerant	R600a

## Chapter 4: Instructions for the operation of the product function

The keys and LED display layout in the human-machine interface are shown in the figure below (the key icon may not match the actual):



### 1, display

- When you first power on, ring the power-on ringtone and enter the normal operation display
- Normal operation display digital display area: there is a freezer failure after three hours to display the fault code, touch any key to exit the fault display, other faults do not show the dominant;
- Display control normal operation, no door opening action, no key operation 20 seconds after the display goes out, each time there is an opening action, or there is a key operation, the display returns to normal display, there is a freezer failure, the first three hours of hidden display, 3 hours after the dominant display, but not very bright, accompanied by the display of the screen, touch any key exit fault display, other faults are hidden display.

### 2, Celsius conversion

Press and hold mode (MODE) about 5S, can be converted to display;

### 3, child lock mode

- In a non-locked state, hold down the Lock child key (LOCK) continuously for 3 seconds, enter the lock state, ring the lock beep, and the lock icon appears as

Locked state;

- In the locked state, hold down the lock child key (LOCK) continuously for 3 seconds, enter the non-locked state, the unlock beep sound, the lock icon appears as unlocked state.

The following keystrokes must be performed in a non-locked state. If you operate in a locked state, the lock icon flashes to prompt.

#### 4, refrigerator temperature setting and cold room switch function

- The temperature of the freezer is set

Press the "FRIDGE" button and the temperature is set

In the following

3 → 2 → 1 → 0 → 6 → 5 → 4 → 3  
order ↑

Fahrenheit (°F): 38 → 36 → 34 → 32 → 43 → 41 → 39 → 38

The default temperature is 38 degrees F (3 degrees C).

- The freezer is closed/open

When refrigeration is on, press and hold the "FRIDGE" button 5s until you hear a beep and enter the refrigeration shutdown state, and when the refrigeration is turned off, press and hold the "FRIDGE" button until you hear a beep and exit the refrigeration shutdown state. The freezer temperature setting returns to the temperature between the refrigeration shutdowns and goes into normal operating mode.

#### 5, freezer temperature setting

Press the Freeze (FREEZER) button and the temperature is set in the following order:

Celsius (°C) : -19 → -20 → -21 → -22 → -23 → -15 → -16 → -17 → -18

Fahrenheit (°F) : -2 → -4 → -6 → -8 → -10 → 5 → 4 → 2 → 0 → -2

Default temperature -2 degrees F (-19 degrees C).

#### 6, holidays, frozen, cold

Each time you press the Mode key, holiday, freeze, freeze, and speed cold, cool, no cycle setting, set or cancel any mode, the icon lights up/off to select/cancel the mode. When setting the holiday mode, the refrigeration automatically sets 6 degrees C, the freezer automatically sets to -15 degrees C, when exiting holiday mode, the set temperature of the freezer and freezer automatically returns to the set temperature before the smart mode, when setting the cold mode, the refrigeration automatically sets 0 degrees C, and when the cold mode is exited, the temperature set by the freezer automatically returns to the set temperature before the cold mode.

#### 7, refrigerator door opening prompt and open the door alarm

When the refrigerator door opens and does not close for 1 minute, the buzzer alarm (three sounds) is raised, followed by three sounds every 30 seconds until the refrigerator and freezer door is closed;

**8, power-off memory**

After the refrigerator is powered off, the re-powering is still working according to the set state before the power failure;

**9, fault tips**

When the display has the following fault, the refrigerator has a fault, some of the fault state refrigerator can still be cooled, but should contact repair as soon as possible to achieve optimal operation of the refrigerator.

	Project	Fault label		Fault content	Remark
		freezer temp	Fridge temp		
1	Normal	Set temp mark		-	Display ok
2	Freezer sensor abnormal	FS	Er	Freezer sensor Disconnection or short circuit	check the sensor line
3	ambinet sensor abnormal	rH	Er	ambinet sensor abnormal disconnection or short circuit	
4	Fridge sensor abnormal	rS	Er	Fridge sensor disconnection or short circuit	
5	Defrost sensor abnormal	dS	Er	Defrost sensor disconnection or short circuit	
6	Bad defrosting	dH	Er	Start defrosting After 70 minutes Defrost sensor less than 5°C	
7	communication abnormal	CO	Er	Control board processor and display board Communication between the mechanisms	Abnormal communication transmission
8	Freezer motor abnormal	FF	Er	When the motor is running for more than 30 seconds without a backfed signal	Motor wiring and Drive IC, TR undesirable
9	Condensor motor abnormal	CF	Er	When the motor is running for more than 30 seconds without a backfed signal	Motor wiring and Drive IC, TR undesirable

# Chapter 5: Electrical schematics and wiring diagrams

## A . Electrical schematics

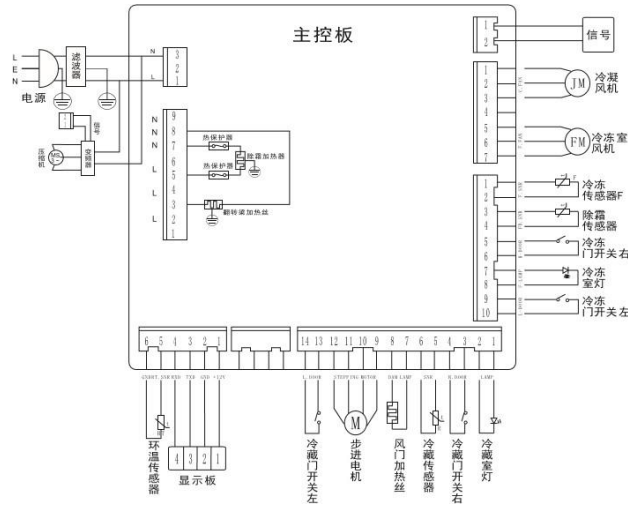

Second, the main control board physical map

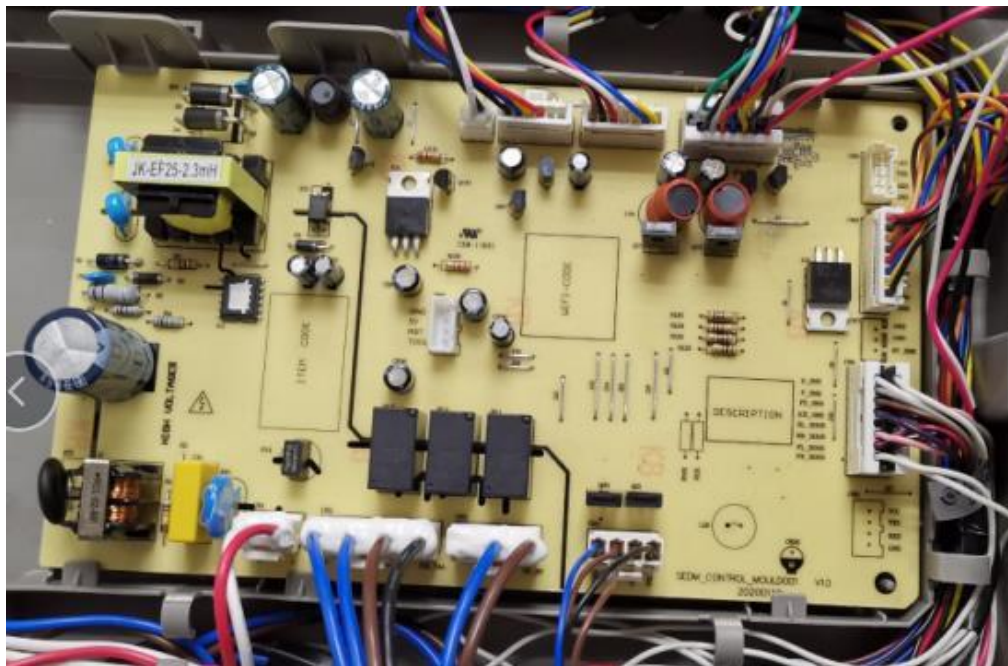

## Chapter 6 Control principles, parameters, and detection methods

**1, refrigerator control:** refrigeration on state, press and hold the "refrigerator" key for 5 seconds, until you hear a beep, into the refrigeration closed state.

When refrigeration is off, press and hold "FRIDGE" for 5 seconds until you hear a beep and exit the refrigeration shutdown state.

**2, freezer control:** according to the "frozen temperature adjustment(FREEZER)" can adjust the freezer temperature;

**3, holiday, frozen, cold control:** press the "mode" key once, the holiday icon lit, no key operation after 10S effective;

Press the Mode key twice, the freeze icon lights up, 10S takes effect without a keystroke, the Mode key is pressed four times, the cool icon is lit, and refrigeration forces the display 10S to take effect after no keystroke action.

**4, open the door alarm:** when the refrigerator door opens 60S, every 30S display board buzzer sound three.

**5, refrigeration lighting control:** when the refrigerator door opens, the refrigerator lighting lights on;

### 6, fan control:

The freezer fan motor is switched on if one of the following conditions is met:

- ( non-chemical cream state compressor on the start ) AND (refrigeration room, freezer door closed);
- (When non-cream state compresses the machine and refrigeration requests refrigeration) AND (refrigeration room, freezer door closed). Note: The fan meets the opening conditions after the freezer door is closed, and the delay is 10s.

8.2 The freezer fan motor is stopped if one of the following conditions is met:

- Compressor shutdown and refrigeration non-cooling state;
- Freezer cream status;
- The freezer door or freezer door is open for less than 4 hours (if the door is opened for more than 4 hours, it is restored to its original state).

### 7, door control:

7.1 The refrigerator door is closed if one of the following conditions is met:

- Refrigeration sensor temperature  $T_{ra} \leq$  Refrigeration stop point temperature  $T_{rt}$
- During the defrosting process

7.2 The freezer door is open if:

- (Non-defrosting process) AND (non-refrigerated shutdown mode) AND (refrigeration room sensor temperature  $T_{ra} \geq$  freezer boot point temperature  $T_{rk}$ );
- After defrosting exits 17min, the press meets the start-up conditions or refrigeration requests after refrigeration;
- The freezer room is closed.

7.3 The door state is abnormally controlled

- a. The door continues to open 60min door reset once.
- b. The door is continuously closed 60min door reset once.

**8, display control:** no key operation (the last operation will prevail)20 seconds display off, refrigeration room or freezer door open when the display lights up

(detect only one door signal at a time);

**9, press protection:** press every shutdown 7min can be turned on again,7min delay after the end, can enter the normal control of the press;

10,press model and main parameters

Press model	factory	power	Energy efficiency ratio	Cooling capacity	Operating current	Maximum start-up power flow
VTH1113Y A	jiaxipera	36.4-131.1W	1.65— 1.73	60-215W	0.35— 1.10A	1.60A

11, **force mode:** press the display board "freeze "(FREEZER)" button and "mode" button for 5 seconds, the display board all

shows that you enter forced cooling mode, where you press the Freeze (FREEZER) button and mode buttons for 5 seconds at the same time, display four 0s,enter the mandatory cream mode, and press the Freeze (FREEZER) button and in this mode at the same time Mode key for 5 seconds, exit force mode, and return to normal display.

## Chapter 7: Refrigeration principles and pipe cycle diagrams

### 1. System cooling schematic:

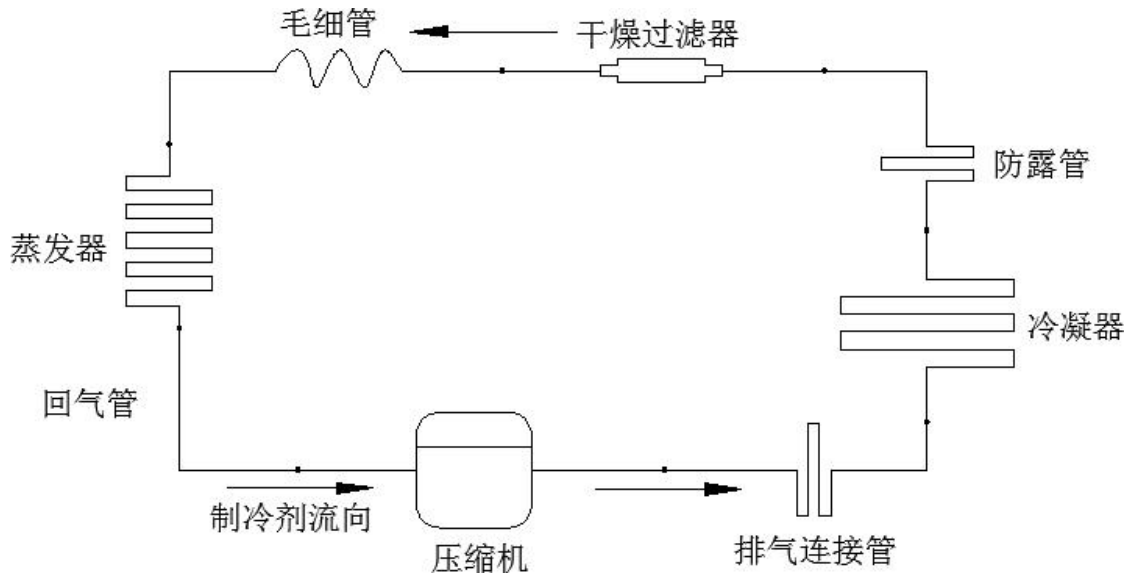

### 2. Line cycle diagram: Weld distribution

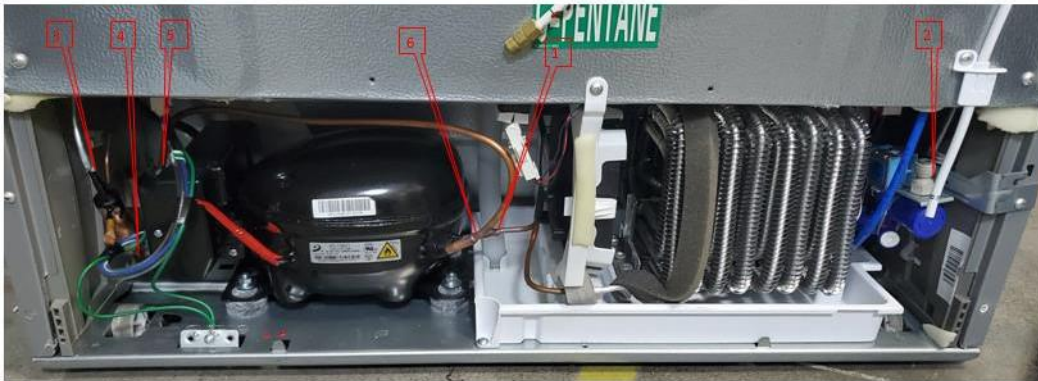

Compressor --- solder joint 1 ( brazing )---- exhaust connection pipe -- solder joint 2 (ring welding) ---- rotary fin condenser -- solder joint 3 (ring welding) --- dew pipe -- weld point 4 ( Brazing

Welding)---- drying filter -- soldering point 5 ( brazing )---- capillary pipe ----- return pipe --- solder joint 6 (ring welding)--- compressor suction tube -- soldering point 7 ( brazing ).

---- compressor

## Chapter 8: Instructions for the removal of major components

### First, the door body removal mode

1, remove the upper hinge cover

(1),the use of simple plum screwdriver to remove the upper hinge cover screws;

(2),remove the door light switch terminal;

(3),unplug the door light switch can remove the hinge cover;

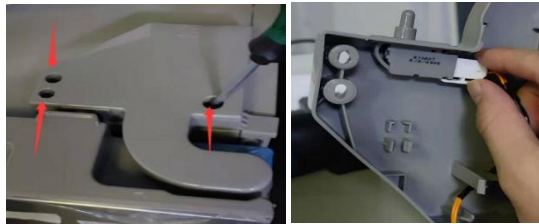

2, remove the upper hinge



Remove the upper hinge screw and use a simple plum gun / wrench / 6 angle with an 8mm socket wrench;

3, the removal of the frozen door body

(1) pull out the frozen door body completely, grasp the front of the freezer drawer, lift up and remove the upper drawer;

(2)Remove the left and right fixing screws using a simple plum screwdriver:

(3),grasp the front of the frozen drawer, lift up to remove the frozen drawer;



(4),hold the frozen door body, lift up, you can remove the freezer door;

**Second, the display control plate removal mode**

1, take the suction cup against the display control plate, pull out, pull out the terminal can remove



the display plate.

**Third, the compressor assembly removal method**

1, remove the compressor rear cover: use plum screwdriver to remove the screws.



(1)

(2)

2, remove the compressor assembly (warning: refrigerant R600 for flammable and explosive gas, the repair process needs professional refrigerator maintenance personnel to operate, in determining that

## BCD-513W

The first edition of the refrigerator can be effectively ventilated around, repair space to meet 10m<sup>2</sup> above two conditions):

- 1, the line cut short (with the pipe cutter operation, prohibit the use of flame welding open);
- 2, after cutting open the line free volatile refrigerant 30 minutes after the vacuum parameters meet the 10Pa or less to fill, the third step is to use seal clamps after the line clamping using a simple



welding gun welding (note that the strong clamp clamp must be free of refrigerant leakage).

- 3, remove the compressor / capacitor

(1),the compressor assembly is placed flat on the workbench, the fixed screws are removed with a wrench, and the remaining 4 are removed in turn;

(2),replace the capacitor (wrench) after removing the capacitor screw at the bottom of the compressor assembly.

Remove the starter/protector

(3),the compressor flat on the work surface using a screwdriver to pry the shield open;

(4),by hand to pull the starter / protector out;

(5)Replace the starter/protector by separating the terminals from the inserts with a one-word



screwdriver.

### **Fourth, remove the refrigerator accessories and refrigeration door dud cover**

1, open the refrigerated door, holding the front of the refrigerated glass shelf by hand, take the glass shelf removed from the outside, three methods are the same;

2, fruit box cover and glass shelf removal method is consistent;

- 3, fruit box pulled out to the maximum travel, lifted to remove;
- 4, first pull out the refrigerated medium partition near end, take the outer can be removed from the middle partition;
- 5, pull the refrigerated upper air duct cover plate part, pull forward, remove the terminal, can remove the refrigerated upper air duct cover;
- 6, seize the refrigerated duo foam, pull forward, you can remove the refrigerated duo foam;



**V. Mid-hinged removal**

- 1, the use of plum screwdrivers to the middle hinge fixed in the beam and side panel screws removed;
- 2, the use of pneumatic guns to remove the middle hinge fixing screws;



- 3, will be left and right hinges in turn to remove the completion of removal.

**Six, remove the frozen lamp board**

1 Use an art knife to remove the lamp cover outwards and open the limit refrigerated lamp board



claws outwards to complete the removal of the lamp board.

**Seven, guide seat removal**

Remove the two sides of the fixing screw with a cross screwdriver and remove the guide seat to



complete the removal.

**Eight, bottle frame removal**

Two hands grasp the outside of the bottle box along the inward squeeze, pull out can be;

**Nine, frozen drawer rail bracket removal**

### BCD-513W

The first edition of

Tap the frozen rail stand on the side plate side, the claws out of the stand Complete removal.



### Ten, frozen air duo cover removal

Remove the two sides of the fixed screws with a cross screwdriver;

Grasp the front of the frozen duct cover by hand and pull forward hard to remove the wind tunnel cover;

Pull out the frozen air duo cover terminals to complete removal.



### Eleven, remove the rail, semi-rail

1、 Refrigeration room

rail is equipped with the

2、 Freezer rail removal



fixing screws, the

the removal;

r to complete the



removal;

### Fifteen, the main control board removal mode

Use a plum screwdriver to remove the main control plate power box cover screws and wear anti-static measures to remove the main control board;

Wearing anti-static measures, pull the harness terminals up and separate the terminals from the main control panel;

## BCD-513W

Remove the power switch limit claws outwards and the main control plate along the open side.

The first edition of

XVI

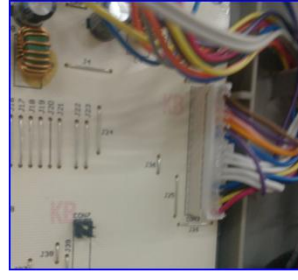

### VARIABLE FREQUENCY PRODUCT PARTS REPLACEMENT:

The filter interface has a total of 5 interfaces, of which L2-N4 plugs the power cord terminals into the input terminals. The U1-U3 is the output and the plug-in filter cable supplies power to the main control plate.

Where L2 is the fire wire, U1 is the fire wire, N4, U3 is the zero wire, pay attention to the plug-in cable can not be confused, must be plugged according to the color matching terminals, otherwise there will be a short circuit causing the power cord to burn.

The docking diagram looks like the image on the left:

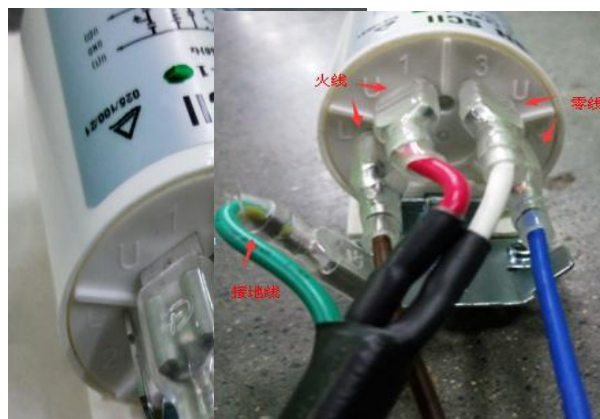

## Chapter 9: Typical troubleshooting and troubleshooting

### One Common failures and troubleshooting of refrigeration systems:

#### 一、 Refrigeration systems Common faults and troubleshooting:

phenomenon	Fault analysis
The refrigerator is not cooled	Cause 1: Compressor does not start: Check whether the PTC starter is damaged and the main board supply voltage is ok
	Reason two: compressor frequently jump: check if the overload protector is damaged;
	Reason 3: Compressor frequently jumps: check if the overload protector is damaged;
	Reason 4: Whether the refrigeration system is blocked
One room of the refrigerator is not cooled	Reason one: check whether the main control board plug-in is loose, contact with undesirable phenomenon;
	Reason two: if the refrigerator is not refrigerated, check whether the refrigeration fan is running, check the refrigeration fan when the door light switch is pressed, after 5S inspection;
The refrigerator is not cool enough	Cause one: Check the refrigerant for leaks;
	Reason 2: Check whether each fan is running: Open the door and observe if the air vents are blowing. When checking the refrigeration fan, press the door light switch and check after 5S.
	Reason 3: Check whether the freezer evaporator frost seriously blocked the air duo, the frost is normal.
Unusual noise	Cause one: check whether the lines are touching, the compressor has resonance;
	Reason 2: Check whether the exhaust temperature is too high, if the exhaust pipe temperature is too high (ring temperature should not exceed 60 degrees C) may be mixed into the system air, causing noise anomalies;
	Cause 3: Freezer or refrigeration fan noise check whether the fan leaves interfere with other components.

#### 二、 Electroniccontrol systems

##### Common troubleshooting:

Fault	Possible causes	Repair method
The display is not displayed and the light is not on	Whether the power supply is on, whether the plug is plugged in, whether the power plug-in is in good contact	Plug in or plug in or plug in the plug-in
	The fuse (fuse) on the main control plate is blown	Replace the fuse
	The main control board power supply socket is in poor contact	Plug in the plug
The display is not displayed	The socket on the signal harness connecting the display board to the main control board is in poor contact	Plug in the plug

and the light is on	The signal connection harness is disconnected	Repair or replace the harness
	The display panel is damaged	Repair or replace
The display shows that the normal compressor is not working	The compressor plug-in is in poor contact	Plug in the plug
	The main control board is damaged	Repair or replace
	Two of the compressors were damaged	Repair or replace
	The compressor is damaged	Repair or replace
The freezer is not cooled	The electronic control board is damaged	Repair or replace
The freezer is not cooled	The fan blades of the freezer fan motor fall off	Reinstall and tighten the fan leaves
	The freezer fan motor does not turn	Check the plug-in or replace it
Freezer frosting	The refrigerator fan motor does not turn	Check the plug-in or replace it
	The return duo is blocked	Clean the duo
	The cream heater or sensor is bad	replacement
The freezer frost is severe	The cream circuit connector comes off	Plug in the plug
	The cream heater or sensor is bad	replacement
The compressor will lose power as soon as it works	Refrigeration system failure	Follow the instructions of the previous system pieces to troubleshoot
The compressor does not work	Check that the compressor harness is properly connected	Show reconnection
	The electronic control board is damaged	Replace the main control board
The key is not working	The keys (springs) are not assembled properly	Reinstall and adjust the position
	The touch capacitor is bad	Repair or replace
	The display panel is damaged	Repair or replace

### 三、Major electrical component failure:

Electrical parts	Fault	The detection method	Repair method
Cream heater/fuse	There is a cream action, no frost	The multimeter tests the resistance of the cream heater, with a resistance of about 252 ohms, and the test freeze fuse is switched on (the multimeter diode is switched on).	Heater damage replacement heater; fuse damage replacement fuse;

**BCD-513W**

The first edition of

Electric door	The freezer is not cooled	In non-commercial inspection mode, set the greenhouse temperature to -18 degrees C, check by hand whether there is wind in the greenhouse air duct mouth	Check that the door harness connector is ok and replace the main control plate, otherwise replace the door
Lights	The light is not on	1. Check if the connector is well connected 2. Check that the excuse of the lamp on the motherboard is normal power supply 3. All not on, check the door light switch and communication line 4. Some of the lamp beads are not on, change the light plate	
Fan motor	The freezer cools down slowly, and the temperature of the change room does not drop	Check that the motherboard freezer terminals are powered and that the fan is blocked	The motherboard is bad to replace the motherboard, the fan blocking the reinstall

### Fault code prompt and index

No	project	Fault identification		Breakdown contents	remark
		frozen temperature	refrigeration temperature		
1	normal	Set the temperature indication		-	The display is OK
2	Refrigeration sensor abnormal	he	FS	Refrigeration sensor Open or short circuit	Sensor Wiring Check
3	Ambient temperature Sensor abnormal	he	rH	Ambient temperature The sensor is off or shorted	
4	Refrigeration sensor 1 is abnormal	he	rS	Refrigeration sensor 1 is open or shorted	

**BCD-513W**

The first edition of

5	Refrigeration sensor 2 abnormal	he	r2	Refrigeration sensor 2 is open or shorted	
6	The defrost sensor is abnormal	he	Ds	Defrost sensor Break or short circuit	
7	Defrost bad	he	dH	Start Defrost After 90 minutes The defrost sensor is less than 6 degrees C or more	Temperature Protector Disconnected, Heater Disconnected, Drain Pipe Blocked, Heater Relay Is Not Good
9	Communication exception	he	CO	Control board processor and the display board processor correspondence	Communication delivery exception
10	The refrigeration motor is abnormal	he	Ff	When the motor is running for more than 30 seconds without a feedback letter number	Motor wiring and Drive ICs, TRs, etc. are not good
11	The condensing motor is abnormal	he	CF		

## Chapter 10: Product Breakdown Chart and Parts Schedule

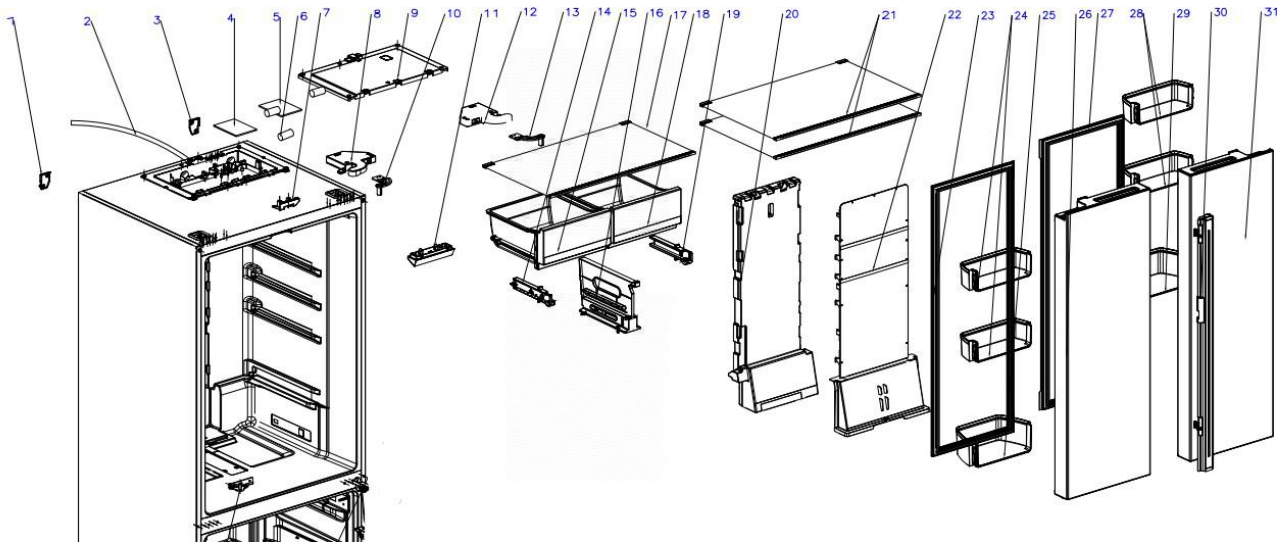

Serial NO	Name - Description CN	English name - Description EN	Coding - Parts code	Material	Quantity - Qty
1	The rear corner cover is left	Rear corner cover left	GS000240806	PP	1
2	The power cord assembly	Power cord assembly	DA000042201	subassembly	1
3	The rear corner cover is right	Rear corner cover right	GS000240906	PP	1
4	Master board	Main control board	DA000039004	subassembly	1
5	Variable frequency control board	Frequency conversion control board	DA000028001	subassembly	1
6	filter	wave filter	DA010283002	subassembly	1
7	Guide seat components	Guide seat assembly	GA000514601	subassembly	1
8	Left hinge cover assembly	Cover as-hinge-left	GA0000239L2	subassembly	1
9	Power control box cover assembly	Power control box cover assembly	GA000015806	subassembly	1
10	Upper hinge welding assembly	Upper hinge welding assembly	GA0004021L1	subassembly	1
11	Top lamp assembly	Internal display and control unit	GA000812001	subassembly	1
12	Upper hinge cover assembly	Cover as-upper hinge	GA000563302	subassembly	1

13	Upper hinge welding assembly	Upper hinge welding assembly	GA0004021R1	subassembly	1
14	One-wheel left short rail assembly	Single wheel left short guide rail assembly	GA000016301	subassembly	1
15	Left fruit box drawer set,W756	Drawer assembly of left fruit and vegetable box	GA000065702	subassembly	1
16	Refrigerate the components in refrigeration	Partition assembly in refrigeration	GA000056901	subassembly	1
17	Fruit box cover assembly	Fruit and vegetable box cover assembly	GA000069801	subassembly	1
18	Right fruit box drawer set,W756	Drawer assembly of left fruit and vegetable box	GA000065702	subassembly	1
19	Single-wheel right short rail assembly	Single wheel right short guide rail assembly	GA000016401	subassembly	1
20	Refrigerated air duo foam group	Refrigerated duct foam assembly	GA000053401	subassembly	1
21	Refrigerate the shelf assembly	Shelf as-refrigeration	GA000066401	subassembly	1
22	Refrigerated air duo cover panels	Cover assembly of refrigeration air duct	GA000053301	subassembly	1
23	Refrigerate the door seal assembly	Refrigeration door seal assembly	GA000077801	subassembly	2
24	on the bottle box	Gall bottle frame	GS000081701	GPPS	4
25	Gallon bottle frame	Gall bottle frame	GS000081701	GPPS	2
26	Refrigerate the left foaming door body	Refrigerated left foam door body	GA000067903	subassembly	1
27	Refrigerate the door seal assembly	Refrigerated left foam door body	GA000077801	subassembly	1
28	Gallon bottle frame	Gall bottle frame	GS000081701	GPPS	1
29	Flip the beam assembly	Flip beam assembly	GA000081101	subassembly	1

**BCD-513W**

The first edition of

30	Refrigerate the right foaming door body	Refrigerated right foam door body	GA000068003	subassembly	1
----	---	-----------------------------------	-------------	-------------	---

31	Show the dashboard	Display control panel	DA000027002	subassembly	1
----	--------------------	-----------------------	-------------	-------------	---

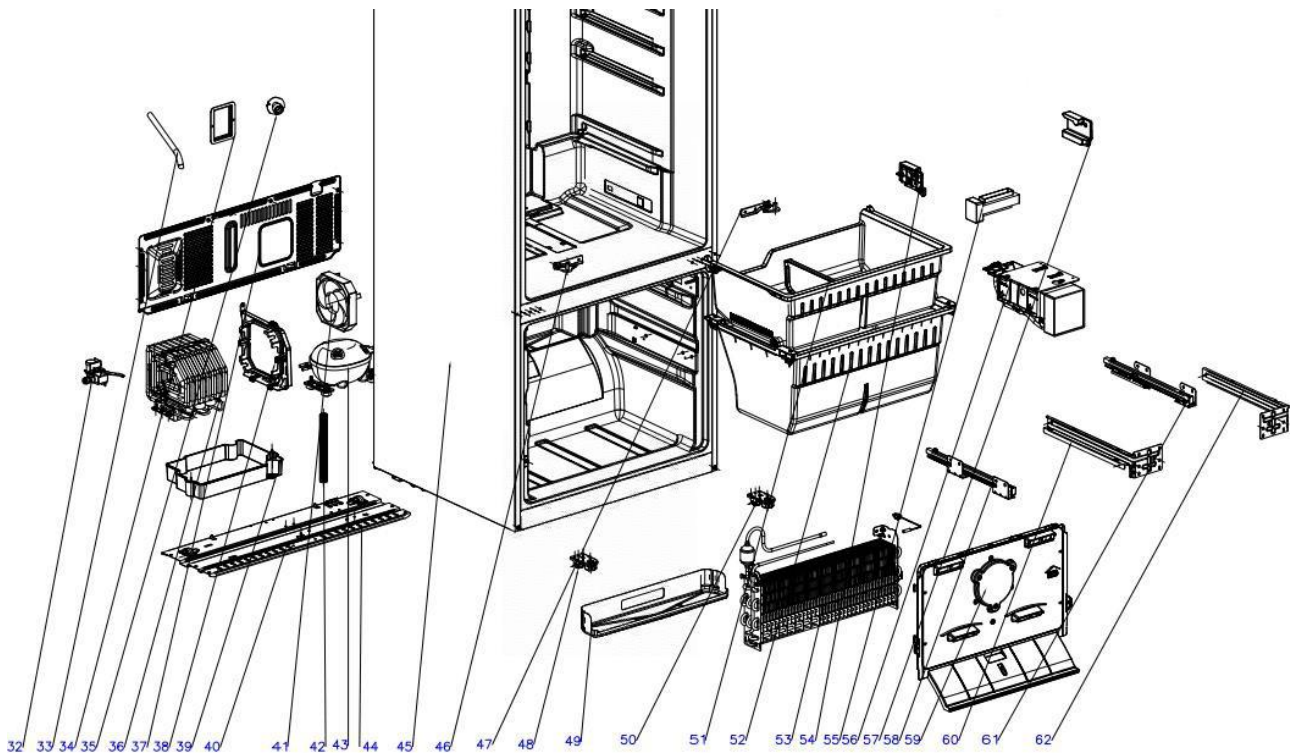

32	Show panel film	Display panel lamination	GA000048801	subassembly	1
33	Water valve assembly	Valve as-water	DA010130302	subassembly	1
34	Ice machine inlet water conduit assembly	Intake pipe assembly of ice maker	GA000038301	subassembly	1
35	The water pipe cover	Water inlet pipe cover	GS010112201	PP	1
36	Ice box water quick connector assembly	Water inlet quick connector assembly of ice making box	GA020112301	subassembly	1
37	Condenser assembly	Condenser assembly	LA000597801	subassembly	1
38	Compressor rear cover assembly	Compressor rear cover plate assembly	GA000045201	Galvanized steel plate	1

**BCD-513W**

The first edition of

39	Condensing fan stand	Condenser fan bracket	GS000555801	subassembly	1
----	----------------------	-----------------------	-------------	-------------	---

40	The main assembly of the water tank	Water box assembly	GA000045601	subassembly	1
41	The compressor base plate assembly	Compressor bottom plate assembly	GA000046201	subassembly	1
42	One-body condensing motor	Integrated condensing motor	DA000560701	subassembly	1
43	drainpipe	a drain	GK000008302	subassembly	1
44	Compressor components	Compressor assembly	LA000006501	subassembly	1
45	Foaming box	Foam box	GA000067501	subassembly	1
46	The left component of the middle hinge	Middle hinge left assembly	GA0000583L2	subassembly	1
47	The right component of the middle hinge	Middle hinge right assembly	GA0000583R2	subassembly	1
48	Roller support assembly - left	Roller support assembly - left	GA0000065L2	subassembly	1
49	Water tray	Water pan	GK000008302	subassembly	1
50	Roller support assembly - right	Roller support assembly - right	GA0000065R2	subassembly	1
51	Refrigerate the drawer assembly	Freezing upper drawer assembly	GA000078101	HIPS	1
52	Refrigerate the drawer assembly	Freeze lower drawer assembly	GA000078201	HIPS	1
53	Evaporator assembly	Evaporator assembly	LA000009301	subassembly	1

**BCD-513W**

The first edition of

54	Upper drawer stop - left	Upper drawer stop - left	GS0000446L1	subassembly	1
----	-----------------------------	-----------------------------	-------------	-------------	---

55	Electric door	Electric damper	DA000943001	subassembly	1
56	American ice machine components	American ice maker components	DA000033502	subassembly	1
57	Upper drawer stop - right	Upper drawer stop - right	GS0000446R1	subassembly	1
58	Metal rail - left	Metal slide - left	GA0000048L1	Galvanized steel plate	1
59	Frozen air duo cover plate assembly	Cover assembly of cooling air duct	GA000053301	subassembly	1
60	Rail stand - left	Rail bracket - left	GK0000015L1	Galvanized steel plate	1
61	Metal rail - right	Metal slide - right	GA0000048R1	Galvanized steel plate	1
62	Rail bracket - right	Rail bracket - right	GK0000015R1	Galvanized steel plate	1
63	Drawer door seal assembly	Drawer door seal assembly	GA000042901	subassembly	1
64	Frozen foaming door body	Freezing foam door body	GA000090301	subassembly	1

