



## USER INSTRUCTION

### 28inch TM Freezer Refrigerator



VEFTF2817RBK



VEFTF2817RSL



VEFTF2817RWH

## REFRIGERATOR SAFETY

**Your safety and the safety of others are very important.**

We have provided many important safety messages in this manual for your appliance. Always read and obey all safety messages.



This is the Safety Alert Symbol. This symbol alerts you to potential hazards that can kill or injure you and others. All safety messages will follow the Safety Alert Symbol and either the words "DANGER", "WARNING" or "CAUTION".



Danger means that failure to heed this safety statement may result in severe personal injury or death.



Warning means that failure to heed this safety statement may result in extensive product damage, serious personal injury, or death.



Caution means that failure to heed this safety statement may result in minor or moderate personal injury, property or equipment damage.

All safety messages will alert you to know what potential hazard is, tell you how to reduce the chance of injury, and let you know what can happen if the instructions are not followed.

### **REFRIGERANT GAS WARNINGS / AVERTISSEMENTS GAZ REFRIGERANT**

**DANGER - Risk of fire or explosion. Flammable refrigerant used.**

**DO NOT use mechanical devices to defrost wine chiller. DO NOT puncture refrigerant tubing.**

**DANGER - Risk of fire or explosion. Flammable refrigerant used.**

**To be repaired only by trained service personnel. DO NOT puncture refrigerant tubing.**

**CAUTION - Risk of fire or explosion. Flammable refrigerant used.**

**Consult repair manual / owner's guide before attempting to service this product. All safety precautions must be followed.**

**CAUTION - Risk of fire or explosion. Dispose of property in accordance with federal or local regulations. Flammable refrigerant used.**

**CAUTION - Risk of fire or explosion due to puncture of refrigerant tubing; Follow handling instructions carefully. Flammable refrigerant used.**

**CAUTION-To Prevent A Child From Being Entrapped, Keep Out Of Reach Of Children And Not In The Vicinity Of Freezer (Or Refrigerator).**



**CAUTION-Risk of Fire**



## IMPORTANT SAFEGUIDES

### SAFETY REQUIREMENTS

**DANGER:** Risk of fire or explosion. Flammable refrigerant used. Do not puncture refrigerant tubing.

- Do not use mechanical devices to defrost refrigerator.
- Ensure that servicing is done by factory authorized service personnel, to minimize product damage or safety issues.
- If the power supply cord is damaged, it must be replaced by the manufacturer, its service agent or similar qualified person in order to avoid hazard.
- Consult repair manual or owner's guide before attempting to service this product. All safety precautions must be followed.
- Dispose of properly in accordance with federal or local regulations.
- Follow handling instructions carefully.
- Do not store explosive substances such as aerosol cans with a flammable propellant in this appliance.

**WARNING:** Keep ventilation openings, in the appliance enclosure or in the built-in structure, clear of obstruction.

**WARNING:** Do not use mechanical devices or other means to accelerate the defrosting process, other than those recommended by the manufacturer.

**WARNING:** Do not damage the refrigerant circuit.

**WARNING:** Do not use electrical appliances inside the food storage compartments of the appliance, unless they are of the type recommended by the manufacturer.

**CAUTION:** Children should be supervised to ensure that they do not play with the appliance.

**DANGER:** Risk of child entrapment. Before throwing away an old appliance:

- Remove the door or lid.
- Leave shelves in place so that children may not easily climb inside.

**DANGER:** Do not add a lock to the door or lid. This can cause child entrapment and harm.

### SAFETY REQUIREMENTS

This appliance is not intended for use by persons (including children) whose physical, sensory or mental capabilities may be different or reduced, or who lack experience or knowledge, unless such persons receive supervision or training to operate the appliance by a person responsible for their safety.

This appliance is intended to be used in household and similar applications such as:

- Staff kitchen areas in shops, offices and other working environments;
- Farm houses and by clients in hotels, motels and other residential type environments;
- Bed and breakfast type environments;
- Catering and similar non-retail applications.

### GROUNDING INSTRUCTIONS

This appliance must be grounded. Grounding reduces the risk of electrical shock by providing an escape wire for the electrical current.

This appliance has a cord that has a grounding wire with a 3-prong plug. The power cord must be plugged into an outlet that is properly grounded. If the outlet is a 2-prong wall outlet, it must be replaced with a properly grounded 3-prong wall outlet. The serial rating plate indicates the voltage and frequency the appliance is designed for.

**WARNING** - Improper use of the grounding plug can result in a risk of electric shock. Consult a qualified electrician or service agent if the grounding instructions are not completely understood, or if doubt exists as to whether the appliance is properly grounded.

**Do not connect your appliance to extension cords or together with another appliance in the same wall outlet.** Do not splice the power cord. Do not under any circumstances cut or remove the third ground prong from the power cord. Do not use extension cords or ungrounded (two prongs) adapters.



**Prop. 65 Warning for California Residents**

**WARNING:**

Cancer and Reproductive Harm - [www.P65Warnings.ca.gov](http://www.P65Warnings.ca.gov).

## PARTS AND FEATURES

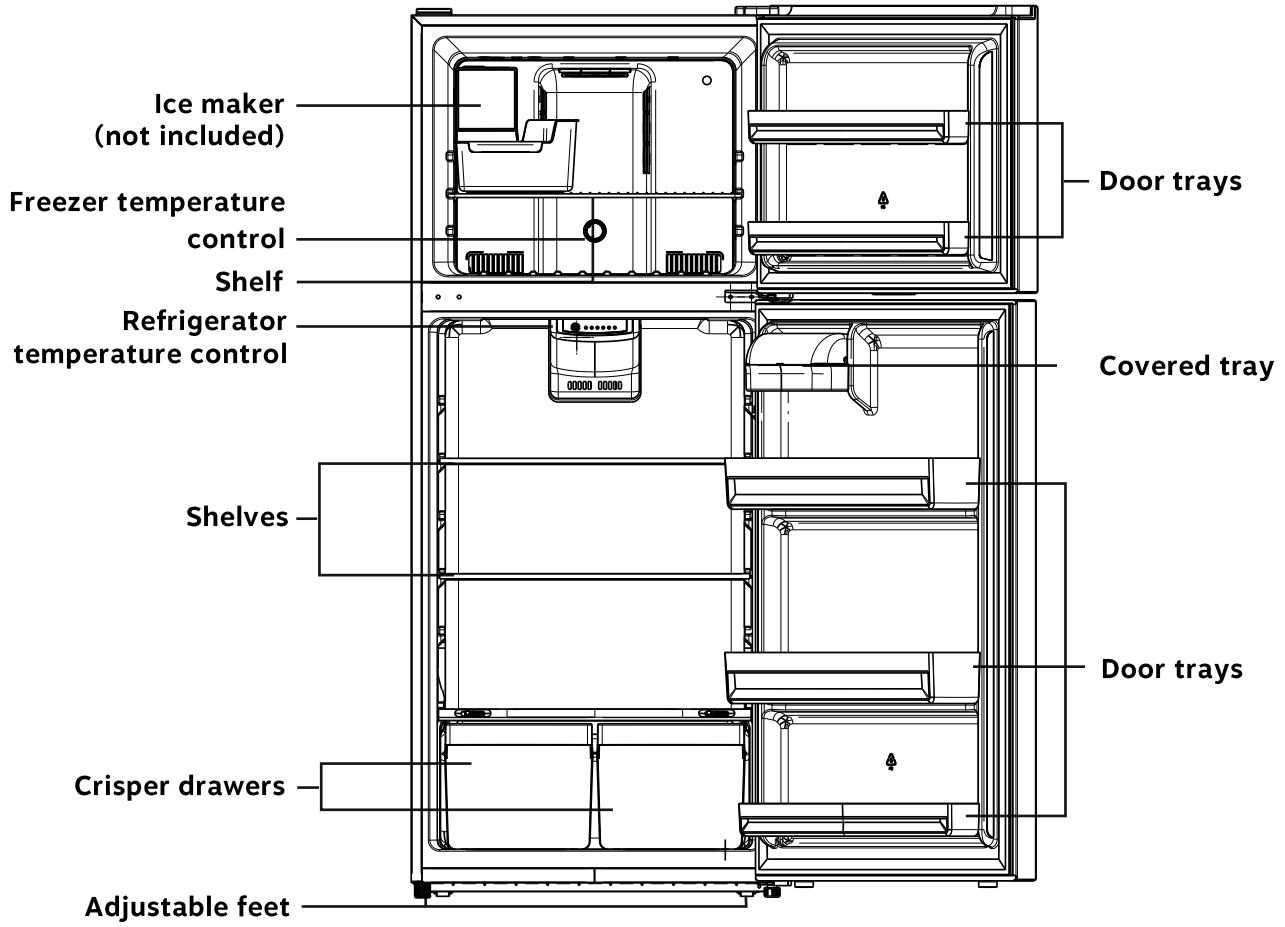

## IMPORTANT SAFETY INSTRUCTIONS

<b>⚡ WARNING ⚡</b>	To reduce the risk of fire, electrical shock, or injury when using your refrigerator-freezer, follow these basic precautions:
<ul style="list-style-type: none"><li>• Read all instructions before using the refrigerator-freezer.</li><li>• <b>DANGER or WARNING:</b> Risk of child entrapment. Child entrapment and suffocation are not problems of the past. Junked or abandoned refrigerator-freezers are still dangerous. . . even if they will “just sit in the garage a few days.”</li><li>• <b>Before you throw away your old refrigerator-freezer:</b> Take off the doors. Leave the shelves in place so that children may not easily climb inside.</li><li>• Never allow children to operate, play with, or crawl inside the refrigerator-freezer.</li><li>• Never clean refrigerator-freezer parts with flammable fluids. The fumes can create a fire hazard or explosion.</li><li>• Do not store or use gasoline or any other flammable vapors and liquids in the vicinity of this or any other refrigerator-freezer. The fumes can create a fire hazard or explosion.</li></ul> <p style="text-align: center;">-Save these instructions-</p>	

## INSTALLATION INSTRUCTIONS

### ➤ Before Using Your Appliance

- Remove the exterior and interior packing.
- Before connecting the unit to the power source, let it stand upright for approximately 2 hours. This will reduce the possibility of a malfunction in the cooling system from handling during transportation.
- Clean the interior surface with lukewarm water using a soft cloth.

### ➤ Installation of Your Appliance

- Place your refrigerator-freezer on a floor that is strong enough to support the refrigerator-freezer when it is fully loaded. To level your refrigerator-freezer, adjust the leveling legs at the bottom of unit.
- Allow 5 inches of space between the back and sides of the unit, which allows the proper air circulation to cool the compressor and condenser.
- Locate the unit away from direct sunlight and sources of heat (stove, heater, radiator, etc.). Direct sunlight may affect the acrylic coating and heat sources may increase electrical consumption. Extreme cold ambient temperatures may also cause the refrigerator- freezer not to perform properly.
- Avoid locating the unit in moist areas.
- Plug the unit into an exclusive properly installed-grounded wall outlet. Do not under any circumstances cut or remove the third (ground) prong from the power cord. Any questions concerning power and/or grounding should be directed toward a certified electrician or an authorized products service center.

## ELECTRICAL CONNECTION

This appliance should be properly grounded for your safety. The power cord of this appliance is equipped with a three-prong plug which mates with standard three prong wall outlets to minimize the possibility of electrical shock.

Do not under any circumstances cut or remove the third ground prong from the power cord supplied. For personal safety, this appliance must be properly grounded.

This appliance requires a standard 115/120 Volt AC ~/60Hz electrical ground outlet with three-prong. Have the wall outlet and circuit checked by a qualified electrician to make sure the outlet is properly grounded. When a standard 2-prong wall outlet is encountered, it is your responsibility and obligation to have it replaced with a properly grounded 3-prong wall outlet.

The cord should be secured behind the appliance and not left exposed or dangling to prevent accidental injury.

The appliance should always be plugged into its own individual electrical outlet which has a voltage rating that matches the rating label on the appliance. This provides the best performance and also prevent overloading house wiring circuits that could cause a fire hazard from overheated. Never unplug the appliance by pulling the power cord. Always grip the plug firmly and pull straight out from the receptacle. Repair or replace immediately all power cords that have become frayed or otherwise damaged. Do not use a cord that shows cracks or abrasion damage along its length or at either end. When moving the appliance, be careful not to damage the power cord.

### ➤ **EXTENSION CORD**

Because of potential safety hazards under certain conditions, it is strongly recommended that you do not use an extension cord with this appliance. However, if you must use an extension cord it is absolutely necessary that it be a UL/CUL-Listed, 3-wire grounding type appliance extension cord having a grounding type plug and outlet and that the electrical rating of the cord be 115 volts and at least 10 amperes.

### ➤ **SURGE PROTECTOR**

Most electrical appliances use a series of electric control boards to operate. These boards are very susceptible to power surges and could be damaged or destroyed.

If the appliance is going to be used in an area or if your city / country is prone to power surges / outages; it is suggested that you use a power surge protector for all electrical devices / appliances you use. The surge protector that you select must have a surge block high enough to protect the appliance it is connected to. If you have any questions regarding the type and size of surge protector needed contact a licensed electrician in your area.

Damages due to power surges are not considered a manufacturer covered defect and will void your product warranty.

## OPERATING YOUR APPLIANCE

### ➤ Setting the Temperature Control

- Your refrigerator has one control for regulating the temperature. The temperature control is located on the top of the refrigerator compartment. As well as a control knob in the freezer to balance the cold air distribution between the two compartments.
- The temperature control in the refrigerator compartment will control the actual cooling cycle whereas the control knob in the freezer compartment will adjust the distribution of the cold air between the freezer and the refrigerator compartments.
- The first time you turn the unit on, adjust the temperature control knob to “COLDER” in the freezer compartment and “5” in the refrigerator compartment and run for at least 4 hours before placing foods inside. This will ensure the freezer cabinet is thoroughly chilled and the refrigerator compartment will be stabilized before food is placed. Then return selector to “**Recommended**” position in the freezer compartment and “3” in the refrigerator compartment.
- Adjust the temperature control to the setting that suits your needs the best. The setting of “3” in the refrigerator compartment and “**Recommended**” in the freezer compartment will distribute the cold air equally between both compartments which should be appropriate for home or office refrigerator use.
- If you at any time want to distribute a larger amount of cold air to the freezer section, for example there's a large amount of food has been added to the freezer, simply move the controller to the “COLDER” position until the desired temperature has been attained then return the controller to the “**Recommended**” position.
- If you at any time want to distribute a larger amount of cold air to the refrigerator section, for example to quickly cool down if a large amount of fresh food has been added, simply move the controller in the freezer to the “COLD” position until the desired temperature has been attained and then return the controller to the “**Recommended**” position.

### **NOTE:**

- IF THE UNIT IS UNPLUGGED, HAS LOST POWER, OR IS TURNED OFF, YOU MUST WAIT 3 TO 5 MINUTES BEFORE RESTARTING THE UNIT. IF YOU ATTEMPT TO RESTART BEFORE THIS TIME DELAY, THE REFRIGERATOR-FREEZER WILL NOT START.

### **NOTE:**

**WE DO NOT RECOMMEND THE INSTALLATION OF THE REFRIGERATOR WHERE THE TEMPERATURE WILL DROP BELOW 50°F (13°C) OR RISE ABOVE 110°F (43°C). THE COMPRESSOR WILL NOT BE ABLE TO MAINTAIN PROPER TEMPERATURES INSIDE THE REFRIGERATOR.**

**FOR INSTALLATIONS WHERE THE TEMPERATURES WILL DROP BELOW 50°F SET THE FREEZER TEMPERATURE CONTROL TO THE “COLDEST” SETTING. THIS WILL IMPROVE THE OPERATIONS OF THE REFRIGERATOR UNDER THESE CONDITIONS.**

### ➤ Freezing Fresh Foods

- Proper use of the appliance, adequately packed food, correct temperature and taking into account hygienic precautions will substantially influence the quality of freezing the food or storing of the frozen foods.
- This compartment is designed for the long-term storage of frozen food.
- The storage life of frozen foods varies and the recommended storage time should not be exceeded.
- Pre-packed commercially frozen food should be stored in accordance with the frozen foods manufacturer's instructions for a three star frozen food storage compartment or home freezer.

- Place frozen food into the freezer as quickly as possible after purchase. If there are instructions on the packet, carefully follow these instructions regarding storage times.
- Carefully select food you intend to freeze, it should be of adequate quality and suitable for freezing.
- Use correct packaging and wrap it tight.
- The packaging should be airtight and shouldn't leak since this could cause substantial vitamin loss and dehydration of foods.
- Foils and bags should be soft enough to tightly wrap around the foods.
- When preparing foods to be frozen, consider sanitary precautions.
- Mark packages with following data: kind and amount of foods and the date of loading.
- It is extremely important that the food is frozen as quickly as possible.
- If the loading amount is too large, the quality of freezing is reduced which affects the quality of frozen foods.

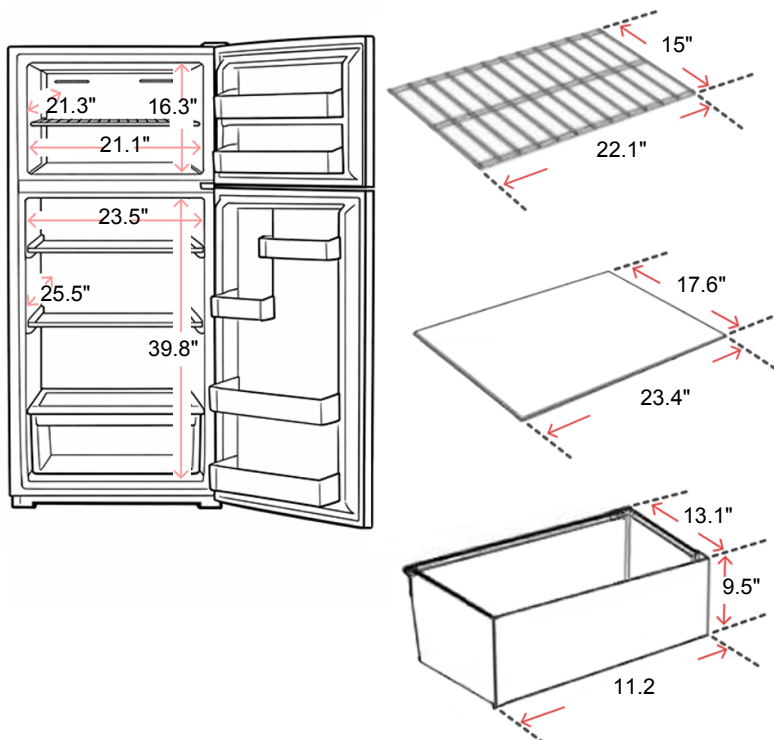
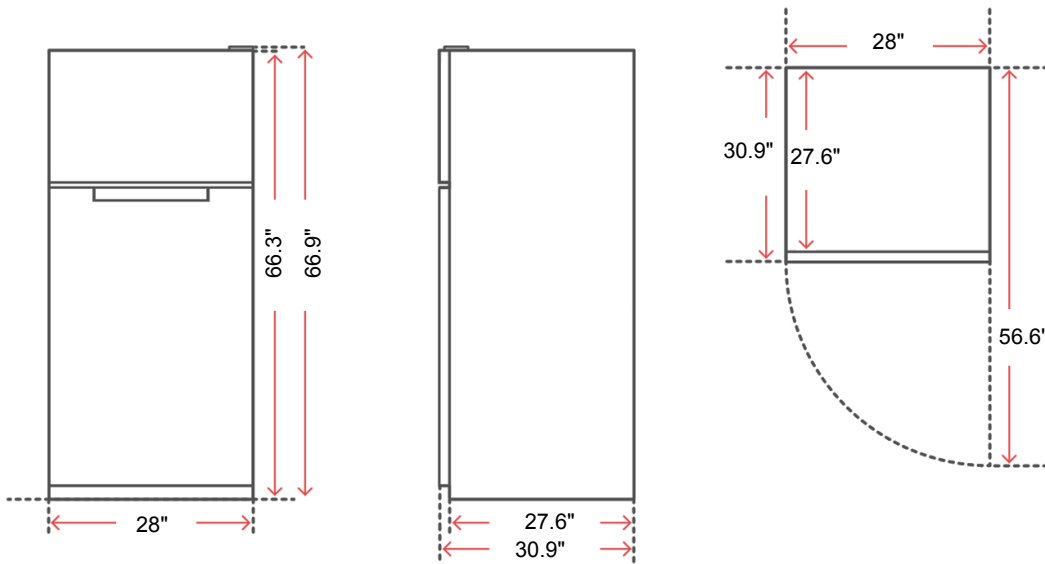

## Reversing the refrigerator door

**CAUTION:** If you lay your refrigerator on its back or side for any length of time, wait for six hours after you stand it up again before you plug it in. Otherwise, you may damage internal components.

You will need the following tool to reverse the refrigerator door:



Phillips screwdriver

- 1 Make sure that your refrigerator is unplugged.
- 2 Remove the screw and the screw hole cover on the top left side of your refrigerator, then remove the screw and hinge cover on the top right side of your refrigerator.
- 3 Remove the screws that secure the upper hinge to the door, then remove the upper hinge.

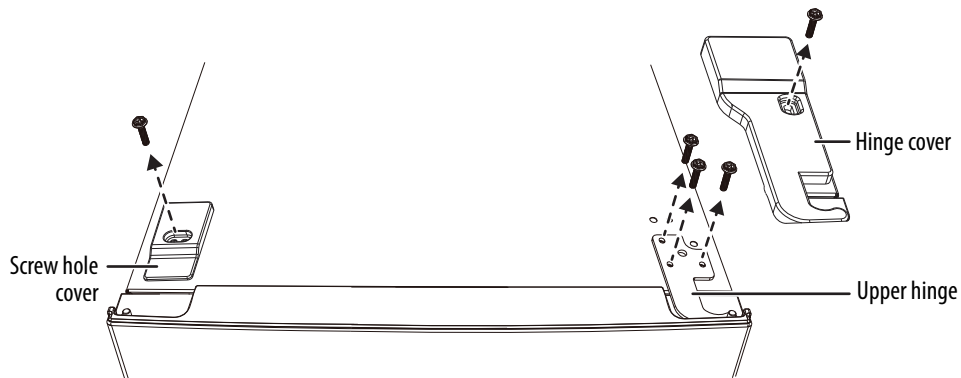

- 4 Remove the freezer compartment door from the refrigerator by lifting it off the hinge pin.
- 5 Remove the hinge pin from the upper hinge, then flip the hinge over and install the hinge pin on the other side of the upper hinge.

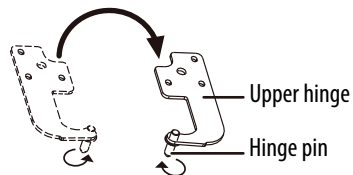

- 6 Remove the two screws that secure the center hinge to the refrigerator, then remove the center hinge.

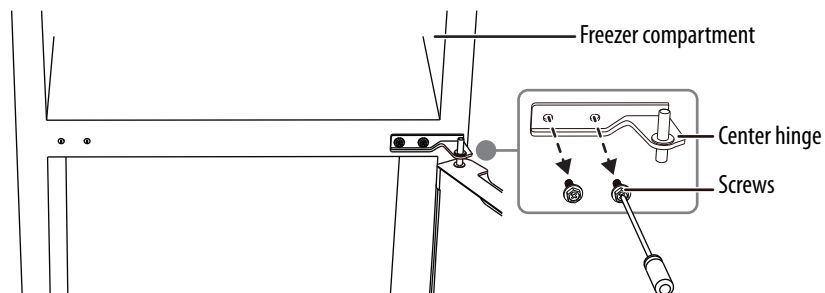

- 7 Remove the refrigerator compartment door.

- 8** Move the hinge hole sleeve from the top right side of the refrigerator door to the top left side of the door, then move the hinge hole cover from the top left side of the refrigerator door to the top right side of the door. Set the refrigerator door aside.

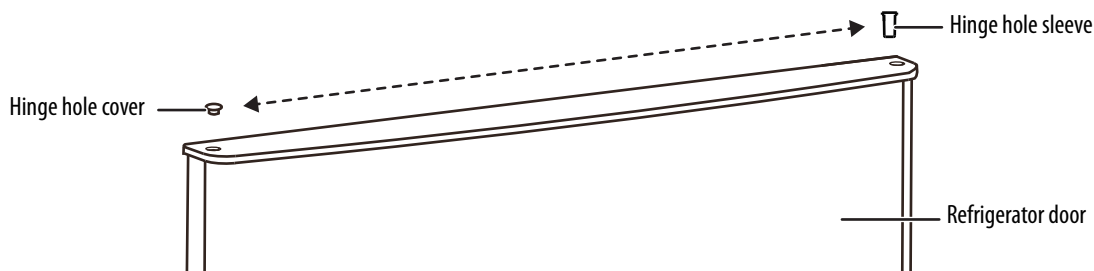

- 9** Remove the screw hole covers from the center left side of the refrigerator and install them in the center right side of the refrigerator.

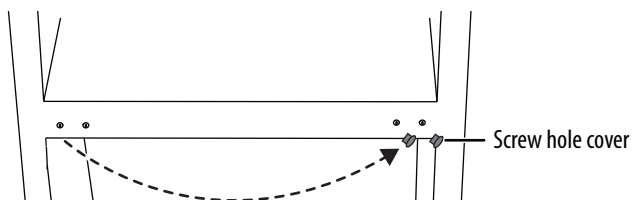

- 10** Lay the refrigerator on its back and remove both adjustable feet from the bottom of the refrigerator, then remove the production-use screw. This screw is for production use only and is not needed after reversing the door.

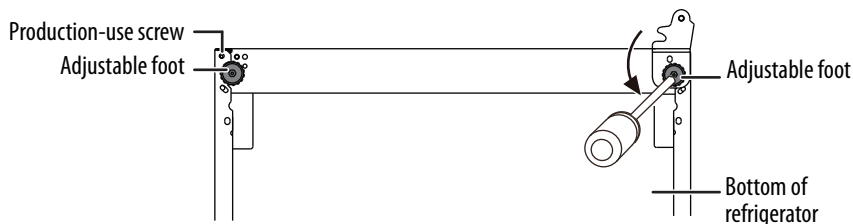

- 11** Remove the screws that secure the lower hinge to the right side of the refrigerator, then remove the hinge.

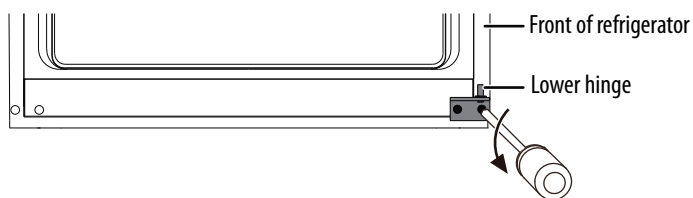

- 12** Remove the screw hole covers from the bottom left side of the refrigerator and install them in the bottom right side of the refrigerator.

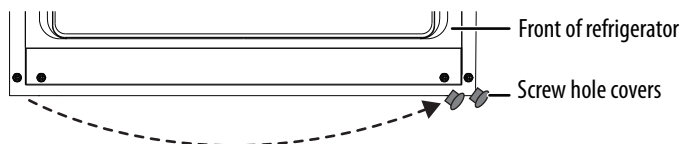

**13** Install the lower left hinge (found in the accessory bag) on the lower left side of the refrigerator.

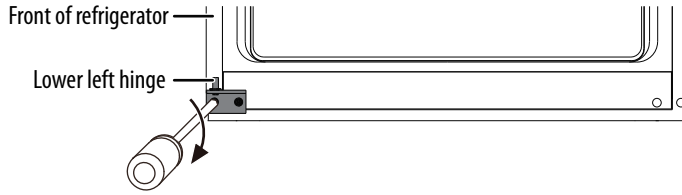

**14** Install the adjustable feet on the bottom of the refrigerator, then set the refrigerator upright.

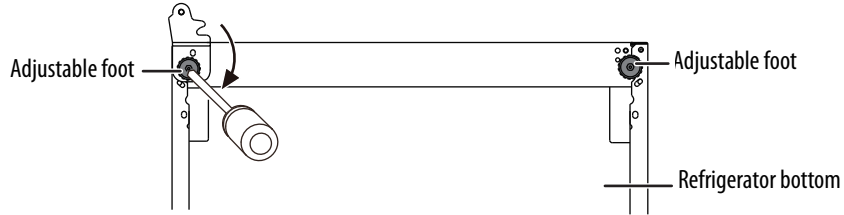

**15** Flip the center hinge, then install the refrigerator compartment door. Install the hinge on the center left side of the refrigerator.

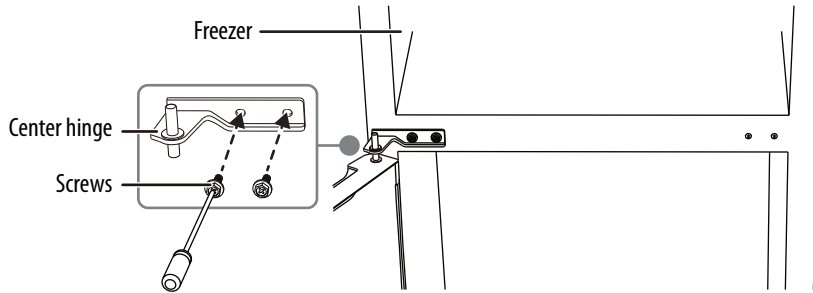

**16** Remove the right aid closer and put it in a safe place, then install the left aid closer (found in the accessory bag) on the freezer compartment door.

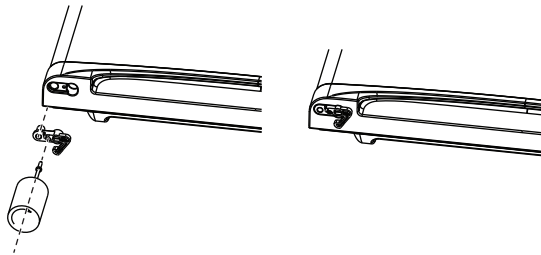

**17** Install the freezer compartment door, then install the upper hinge and the left side upper hinge cover (found in accessory bag) on the top left side of the refrigerator.

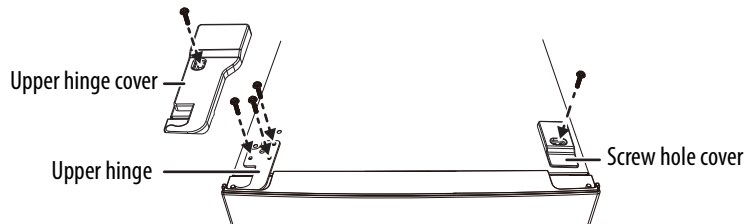

**18** Install the screw hole cover on the top right side of the refrigerator.

## CARE AND MAINTENANCE

### ➤ **Ice Maker Installation**

This refrigerator-freezer has the capability of using an automatic ice-maker. The automatic ice-maker is optional and sold separately. Should you desire to install an automatic ice-maker, please call service for installation instructions.

This product is compatible with the ice maker # GIM-01.

### ➤ **Reversing the Door Swing of Your Appliance**

This refrigerator-freezer has the capability of the door opening from either the left or right side. The unit is delivered to you with the door opening from the left side. Should you desire to reverse the opening direction, please call service for reversal instructions.

### ➤ **Cleaning Your Appliance**

- Unplug the unit, and remove the food and baskets.
- Wash the inside with a warm water and baking soda solution. The solution should be about 2 tablespoons of baking soda to a quart of water.
- Wash the baskets with a mild detergent solution.
- The outside of the unit should be cleaned with mild detergent and warm water.

## **CAUTION**

**Failure to unplug the refrigerator-freezer could result in electrical shock or personal injury.**

### ➤ **Power Failure**

Most power failures are corrected within a few hours and should not affect the temperature of your refrigerator-freezer if you minimize the number of times the door is opened. If the power is going to be off for a longer period of time, you need to take the proper steps to protect your food.

### ➤ **Vacation Time**

**Short vacations:** Leave the unit operating during vacations of less than three weeks.

**Long vacations:** If the appliance will not be used for several months, remove all food and unplug the power cord. Clean and dry the interior thoroughly. To prevent odor and mold growth, leave the door open slightly: blocking it open if necessary

### ➤ **Moving Your Appliance**

- Remove all the food.
- Securely tape down all loose items inside your unit.
- Turn the leveling screws up to the base to avoid damage.
- Tape the door shut.
- Be sure the unit stays in the upright position during transportation.

### ➤ **Energy Saving Tips**

- The unit should be located in the coolest area of the room, away from heat producing appliances or heating ducts, and out of direct sunlight.
- Let hot foods cool to room temperature before placing them in the unit. Overloading the unit forces the compressor to run longer. Foods that freeze too slowly may lose quality, or spoil.
- Be sure to wrap foods properly, and wipe containers dry before placing them in the unit. This cuts down on frost build-up inside the freezer.
- Organize and label food to reduce door openings and extended searches. Remove as many items as needed at one time, and close the door as soon as possible.

## PROBLEMS WITH YOUR APPLIANCE?

You can solve many common refrigerator-freezer problems easily, saving you the cost of a possible service call. Try the suggestions below to see if you can solve the problem before calling for service.

### **TROUBLESHOOTING GUIDE**

<b>PROBLEM</b>	<b>POSSIBLE CAUSE</b>
Unit does not operate.	Not plugged in. The circuit breaker tripped or there is a blown fuse.
Compressor turns on and off frequently.	The room temperature is hotter than normal. A large amount of food has been added to the refrigerator - freezer. The door is opened too often. The door is not closed completely. The temperature control is not set correctly. The door gasket does not seal properly. The refrigerator -freezer does not have the correct clearances.
Vibrations.	Check to assure that the refrigerator - freezer is level.
The unit seems to make too much noise.	The rattling noise may come from the flow of the refrigerant, which is normal. As each cycle ends, you may hear gurgling sounds caused by the flow of refrigerant in your refrigerator - freezer. Contraction and expansion of the inside walls may cause popping and crackling noises. The unit is not level.
The door will not close properly.	The unit is not level. The door is reversed and not properly installed. The gasket is dirty. The baskets are out of position.



# TWO Year Limited Warranty

## Thank you for choosing a Verona appliance for your home.

EuroChef warrants to the original purchaser ("Purchaser") of this product (the "Product"), for a period of two (2) years (except for certain components identified below) from the date of original purchase, that the Product is free from defects in workmanship and materials. This warranty covers all parts and labor required to repair or replace any part of the Product that proves to be defective under normal residential use. To be eligible for this warranty, the Product must be: (i) sold to Purchaser as new product to the original owner by an authorized distributor, retailer, dealer, or service center of Verona Appliances and (ii) installed in the United States. The warranties provided in this statement are not transferable and are valid from the date of purchase.

This limited warranty is valid only provided that written notification of a defect, as well as a copy of the original receipt for the defective Product, is received by EuroChef from Purchaser within thirty (30) days of identification of the defect. EuroChef (who may appoint 3<sup>rd</sup> party agents to act on its behalf in connection with any Product inspection or provision of warranty services hereunder) reserves the right to inspect the Product and its installation. The purchaser is responsible for providing EuroChef authorized service providers and/or representatives with access to the premises at which the Product is installed, and such other information and materials as EuroChef may request, shall be a condition to any claim hereunder. If EuroChef determines that a defect in the Product is covered by this limited warranty, it will, at its expense and as its sole and exclusive obligation for breach of this limited warranty, and Purchaser's sole and exclusive remedy, repair or replace the defective Product. If EuroChef determines that an alleged defect in the Product is not covered by this limited warranty, it shall not have any obligation to repair or replace the Product.

EuroChef will initially attempt to repair any defect in its Products. Only if a Product cannot be repaired after 3 attempts for the same issue by a EuroChef authorized service provider may the Product be replaced with a new Product from EuroChef. In the event EuroChef determines that a defective Product must be replaced, the original retailer on the bill of sale will be contacted to process a replacement order. In the event that EuroChef determines a Product is irreparable, replacement approval may take up to 30 days.

For instances where a Product is installed in a remote area outside of EuroChef's authorized network of service providers, Purchaser is responsible for the travel expenses and associated out-of-pocket costs of EuroChef's authorized service provider. In the event that a product installed in a remote location is deemed to need replacement, the Purchaser is responsible for all delivery costs and risk of loss associated with transportation of the Product to the Purchaser's location.

The Purchaser is responsible for establishing that the appliance has been installed in accordance with all directions and installation instructions included with the Product's accompanying materials at time of purchase. EuroChef shall have no obligation to render any services to correct issues caused by an Installer's failure to follow all directions and instructions. Any expense of repair deemed to be caused by faulty installation shall be payable by Purchaser at EuroChef's then current rates.

A Products' exterior paint and/or lacquer must be cared for according to the instructional materials provided with the Product at time of purchase. If those instructional materials are not followed or harsh chemicals are used, any damages and subsequent repairs to a Product's paint and/or lacquer are not covered by this warranty.

## Component Warranty Periods:

Any components of eligible products showing cosmetic defects, whether in material or workmanship, are covered by this warranty for a period of thirty (30) days from the product's delivery date. Coverage\* is provided for:

- Scratches
- Stains
- Surface Imperfections (ONLY stainless steel)
- Paint & Porcelain Imperfections

\* Excludes slight differences in color due to materials and painting/enameling technologies.

Photo/video proof required to be submitted to [service@veronaappliances.com](mailto:service@veronaappliances.com) in order to be reviewed.

Gaskets are covered by this warranty for a period of ninety (90) days from the product's installation date.

Replacement of glass components and light bulbs are covered by this warranty for a period of thirty (30) days after delivery.

## Exclusions to Warranty Coverage: This Limited Warranty will not apply to any of the following:

- Any service, including repair service to correct damage caused by services performed on the Product by anyone other than an authorized EuroChef service provider, or the use of parts not authorized by EuroChef.
- Defects or damage caused by improper storage, cleaning and maintenance of the Product, including any failure to comply with Manufacturer's written instructions and documentation regarding same.
- Service calls to connect, convert, or otherwise repair the electrical wiring and/or gas line to properly use the Product.
- Replacement of components prone to wear and tear.
- Defects and damage arising from transportation of the Product to the home of the owner, by the dealer/retailer or a hired delivery/logistics provider.
- Defects and damage arising from external forces beyond the control of EuroChef such as fire, flood, earthquakes, and other acts of God
- Accidental or intentional damage.
- Use of improper pans, containers, or accessories that cause damage to the Product.

## **Warranty Void: This Limited Warranty will be void in any of the following circumstances:**

- The Product is used on a commercial, rental, or leased basis
- The serial plate for the Product is defaced
- The Product is altered by anyone other than an authorized EuroChef service provider
- The Product is not used according to Manufacturer's written instructions and documentation regarding same.

THE REMEDIES DESCRIBED ABOVE FOR EACH WARRANTY ARE THE ONLY ONES THAT EUROCHEF WILL PROVIDE, EITHER UNDER THIS WARRANTY OR UNDER ANY WARRANTY ARISING BY OPERATION OF LAW. EUROCHEF WILL NOT BE RESPONSIBLE FOR ANY CONSEQUENTIAL OR INCIDENTAL DAMAGES ARISING FROM THE BREACH OF THIS WARRANTY OR ANY OTHER WARRANTY, WHETHER EXPRESS, IMPLIED OR STATUTORY

This warranty gives you specific legal rights and you may have others which vary from state to state.

For questions, concerns or to start a warranty claim, please contact us at:

PHONE: 631.254.3434

EMAIL: [service@veronaappliances.com](mailto:service@veronaappliances.com) or [service@eurochefusa.com](mailto:service@eurochefusa.com)

WEB: [www.veronaappliances.com/service-verona](http://www.veronaappliances.com/service-verona)

MAILING ADDRESS:

EuroChef  
41 Mercedes Way, Suite 25  
Edgewood, NY 11717